

Ventajas al cuadrado

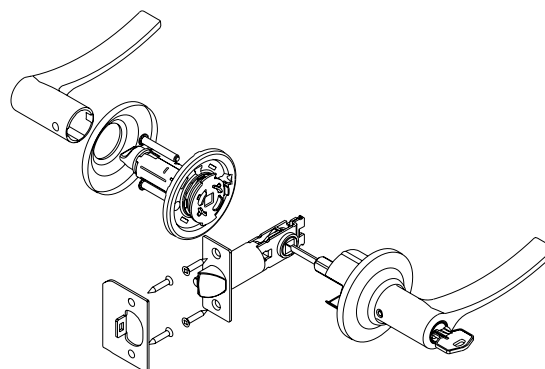

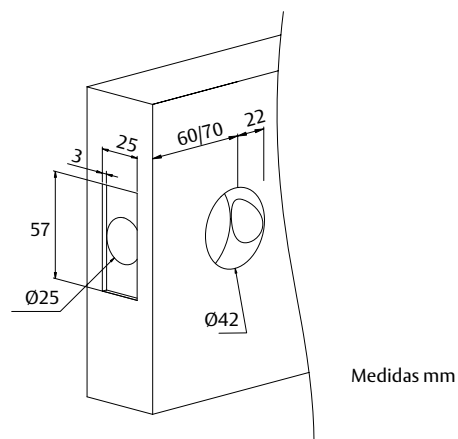

- » Mecanismo multifuncional que sirve tanto para pomo como para manilla, de gran robustez de componentes y accionamiento muy suave.
- » Es aplicable a edificios institucionales de alto tráfico de personas y edificios residenciales de tráfico medio.

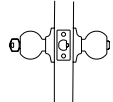
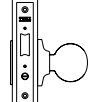
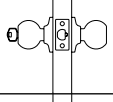
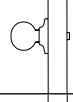
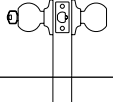
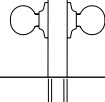
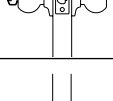
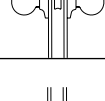
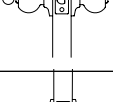

Características	Estandar	Especial
Características técnicas	Picaporte con dispositivo de seguridad antitarjeta en funciones 0, 1 y 2	Función antipánico: en puertas condenadas con llave, el interior siempre es de accionamiento libre
Resistencia anti-corrosión s/ASTM B 117/90	CR,CM,NS144 horas LP,LM 96 horas	
Espesor puerta	33-45 mm manillas 33-52 mm pomos Salvo función 07: 40-50mm	Hasta 75 mm
ANSI A156.2	Grado 2: 400.000 ciclos	
UL		Hasta 1,5 horas de exposición al fuego
Cilindro	5 pitones activos y 3 llaves	Cilindro de seguridad: T60, T80, TX80, T10, T12 Llaves iguales y amaestramietnos
Picaporte	Entrada 60 ó 70 mm - unificado Saliente 12,5 mm	127 mm Frente redondeado
Accesorios	Cerradero, tornillos, instrucciones y plantilla de montaje	Cerradero redondeado
Uds. embalaje	20	
Reversibilidad	Todos los pomos son reversibles - Ojo con las manos de algunas manillas	

Sistemas cuadradillo

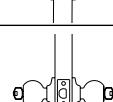
Funciones

Función	Descripción	Función	Descripción
	00 ENTRADA: ambos lados son condenados y descondenados por la llave exterior o la muletilla interior.		20 ENTRADA: condena y descondena por la llave exterior y el pomo interior. Picaporte-palanca. Aplicable a portero automático.
	01 ENTRADA: condena y descondena sólo por la llave exterior. El interior queda condenado.		31 TIRADOR FIJO: fijación pasante desde el interior.
	01AP ENTRADA: condena y descondena sólo por la llave exterior. Desde el interior siempre se puede abrir.		32 DOBLE TIRADOR FIJO
	02 AULAS: el exterior fijo, sólo se abre con llave. El interior siempre se puede abrir.		33 ENTRADA: ambos lados siempre libres, aplicable a cerraduras de embutir. No incluye cerradura.
	03 BAÑOS Y DORMITORIOS: ambos lados son condenados y descondenados por la muletilla interior. Posibilidad de descondena exterior mediante dispositivo de emergencia.		34 ENTRADA: siempre libre, aplicable a cerraduras de embutir. No incluye cerradura.
	05 PUERTAS DE PASO: ambos lados siempre libres.		
	07 OFICINAS: la llave condena y descondena cada lado de forma independiente. La condena no se transmite de un lado a otro de la puerta. Espesor de hoja: 40-50mm		

Interpretación del código

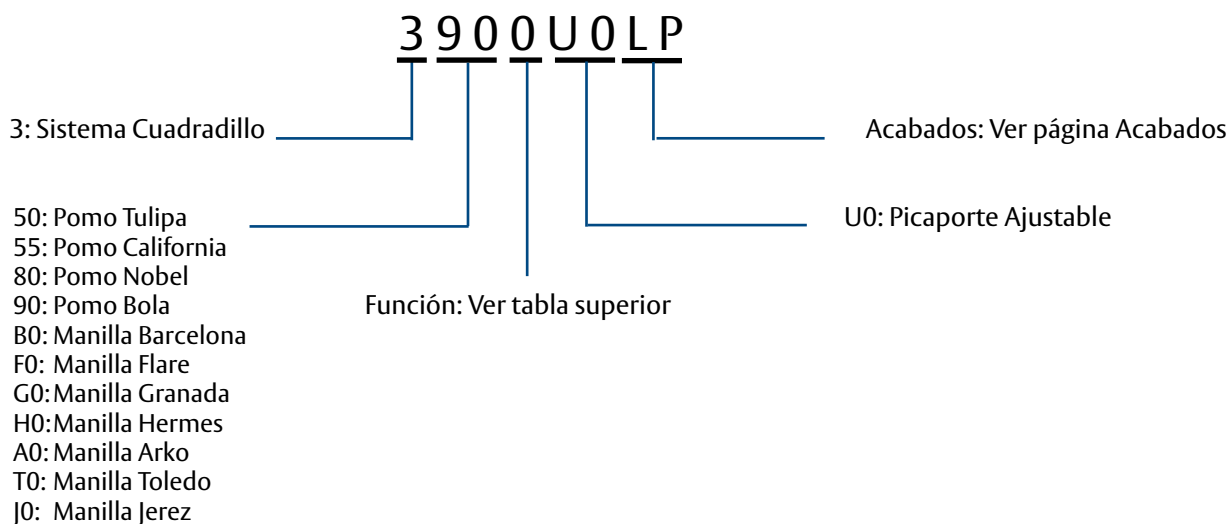

Sistema cuadradillo

Modelos de manillas

Modelo	A	B	C
Arko	65	62	112
Barcelona	65	62	109
Flare	65	62	107
Granada	65	62	119

Modelo	A	B	C
Hermes	65	62	109
Jerez	65	62	115
Toledo	65	62	121

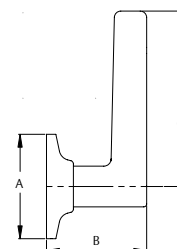

3A00 Arko 3B00 Barcelona



3F00 Flare 3G00 Granada



3H00 Hermes 3J00 Jerez



3T00 Toledo



Serie Flare 3F00

Entrada	Función	Entrada	Acabado	Embalaje
	3F00	U0	CM - CR - LM - LP - NS LA - BL - NE	20

Aula	Función	Entrada	Acabado	Embalaje
	3F02D	U0	CM - CR - LM - LP - NS LA - BL - NE	20

Aula	Función	Entrada	Acabado	Embalaje
	3F02I	U0	CM - CR - LM - LP - NS LA - BL - NE	20

Baño	Función	Entrada	Acabado	Embalaje
	3F03	U0	CM - CR - LM - LP - NS LA - BL - NE	20

Paso	Función	Entrada	Acabado	Embalaje
	3F05	U0	CM - CR - LM - LP - NS LA - BL - NE	20

Oficina	Función	Entrada	Acabado	Embalaje
	3F07	U0	CM - CR - LM - LP - NS LA - BL - NE	20

Pomo - cuadradillo	Función	Entrada	Acabado	Embalaje
	3F34D	00	CM - CR - LM - LP - NS LA - BL - NE	20

Pomo - cuadradillo	Función	Entrada	Acabado	Embalaje
	3F34I	00	CM - CR - LM - LP - NS LA - BL - NE	20

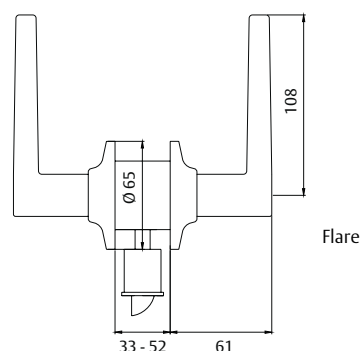

Sistema cuadradillo

Serie Barcelona 3B00

Entrada	Función	Entrada	Acabado	Embalaje
	3B00	U0	CM - CR - LM - LP - NS LA - BL - NE	20
Aula	Función	Entrada	Acabado	Embalaje
	3B02D	U0	CM - CR - LM - LP - NS LA - BL - NE	20
Aula	Función	Entrada	Acabado	Embalaje
	3B02I	U0	CM - CR - LM - LP - NS LA - BL - NE	20
Baño	Función	Entrada	Acabado	Embalaje
	3B03	U0	CM - CR - LM - LP - NS LA - BL - NE	20
Paso	Función	Entrada	Acabado	Embalaje
	3B05	U0	CM - CR - LM - LP - NS LA - BL - NE	20
Oficina	Función	Entrada	Acabado	Embalaje
	3T07	U0	CM - CR - LM - LP - NS LA - BL - NE	20
Pomo - cuadradillo	Función	Entrada	Acabado	Embalaje
	3B34D	00	CM - CR - LM - LP - NS LA - BL - NE	20
Pomo - cuadradillo	Función	Entrada	Acabado	Embalaje
	3B34I	00	CM - CR - LM - LP - NS LA - BL - NE	20

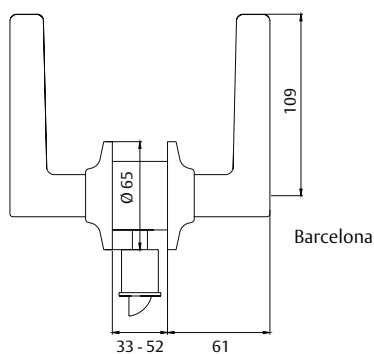

Serie Arko 3A00

Entrada	Función	Entrada	Acabado	Embalaje
	3A00	U0	CM - CR - LM - LP - NS LA - BL - NE	20
Aula	Función	Entrada	Acabado	Embalaje
	3A02D	U0	CM - CR - LM - LP - NS LA - BL - NE	20
Aula	Función	Entrada	Acabado	Embalaje
	3A02I	U0	CM - CR - LM - LP - NS LA - BL - NE	20
Baño	Función	Entrada	Acabado	Embalaje
	3A03	U0	CM - CR - LM - LP - NS LA - BL - NE	20
PAso	Función	Entrada	Acabado	Embalaje
	3A05	U0	CM - CR - LM - LP - NS LA - BL - NE	20
Oficina	Función	Entrada	Acabado	Embalaje
	3A07	U0	CM - CR - LM - LP - NS LA - BL - NE	20
Pomo - cuadradillo	Función	Entrada	Acabado	Embalaje
	3A34D	00	CM - CR - LM - LP - NS LA - BL - NE	20
Pomo - cuadradillo	Función	Entrada	Acabado	Embalaje
	3A34I	00	CM - CR - LM - LP - NS LA - BL - NE	20

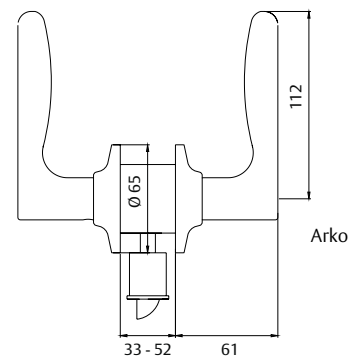

Sistema cuadradillo

Serie Hermes 3H00

Entrada	Función	Entrada	Acabado	Embalaje
	3H00	U0	CM - CR - LM - LP - NS LA - BL - NE	20
Aula	Función	Entrada	Acabado	Embalaje
	3H02D	U0	CM - CR - LM - LP - NS LA - BL - NE	20
Aula	Función	Entrada	Acabado	Embalaje
	3H02I	U0	CM - CR - LM - LP - NS LA - BL - NE	20
Baño	Función	Entrada	Acabado	Embalaje
	3H03	U0	CM - CR - LM - LP - NS LA - BL - NE	20
Paso	Función	Entrada	Acabado	Embalaje
	3H05	U0	CM - CR - LM - LP - NS LA - BL - NE	20
Oficina	Función	Entrada	Acabado	Embalaje
	3H07	U0	CM - CR - LM - LP - NS LA - BL - NE	20
Pomo - cuadradillo	Función	Entrada	Acabado	Embalaje
	3H34D	00	CM - CR - LM - LP - NS LA - BL - NE	20
Pomo - cuadradillo	Función	Entrada	Acabado	Embalaje
	3H34I	00	CM - CR - LM - LP - NS LA - BL - NE	20

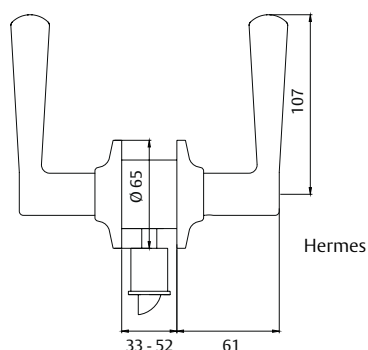





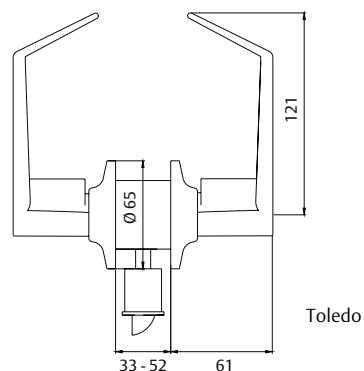

Serie Toledo 3T00

Entrada	Función	Entrada	Acabado	Embalaje
	3T00	U0	CM - CR - LM - LP - NS LA - BL - NE	20
Aula	Función	Entrada	Acabado	Embalaje
	3T02	U0	CM - CR - LM - LP - NS LA - BL - NE	20
Baño	Función	Entrada	Acabado	Embalaje
	3T03	U0	CM - CR - LM - LP - NS LA - BL - NE	20
Paso	Función	Entrada	Acabado	Embalaje
	3T05	U0	CM - CR - LM - LP - NS LA - BL - NE	20
Oficina	Función	Entrada	Acabado	Embalaje
	3T07	U0	CM - CR - LM - LP - NS LA - BL - NE	20
Pomo - cuadradillo	Función	Entrada	Acabado	Embalaje
	3T34	00	CM - CR - LM - LP - NS LA - BL - NE	20







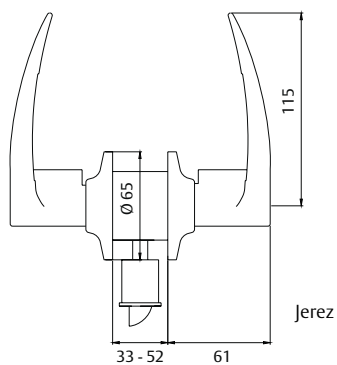

Sistema cuadradillo

Serie Jerez 3J00

Entrada	Función	Entrada	Acabado	Embalaje
	3J00	U0	CM - CR - LM - LP - NS LA - BL - NE	20
Aula	Función	Entrada	Acabado	Embalaje
	3J02	U0	CM - CR - LM - LP - NS LA - BL - NE	20
Baño	Función	Entrada	Acabado	Embalaje
	3J03	U0	CM - CR - LM - LP - NS LA - BL - NE	20
Paso	Función	Entrada	Acabado	Embalaje
	3J05	U0	CM - CR - LM - LP - NS LA - BL - NE	20
Oficina	Función	Entrada	Acabado	Embalaje
	3J07	U0	CM - CR - LM - LP - NS LA - BL - NE	20
Pomo - cuadradillo	Función	Entrada	Acabado	Embalaje
	3J34	00	CM - CR - LM - LP - NS LA - BL - NE	20







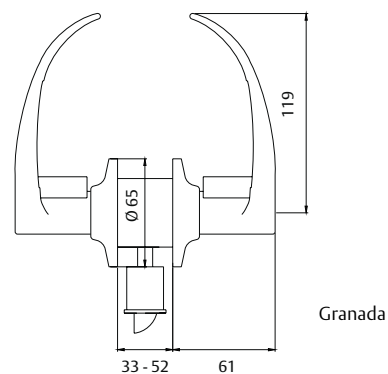

Serie Granada 3G00





Entrada	Función	Entrada	Acabado	Embalaje
	3G00	U0	CM - CR - LM - LP - NS LA - BL - NE	20
Aula	Función	Entrada	Acabado	Embalaje
	3G02	U0	CM - CR - LM - LP - NS LA - BL - NE	20
Baño	Función	Entrada	Acabado	Embalaje
	3G03	U0	CM - CR - LM - LP - NS LA - BL - NE	20
Paso	Función	Entrada	Acabado	Embalaje
	3G05	U0	CM - CR - LM - LP - NS LA - BL - NE	20
Oficina	Función	Entrada	Acabado	Embalaje
	3G07	U0	CM - CR - LM - LP - NS LA - BL - NE	20
Pomo - cuadradillo	Función	Entrada	Acabado	Embalaje
	3G34	00	CM - CR - LM - LP - NS LA - BL - NE	20

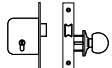

Sistema cuadradillo

Serie Bola 3900

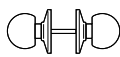
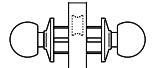

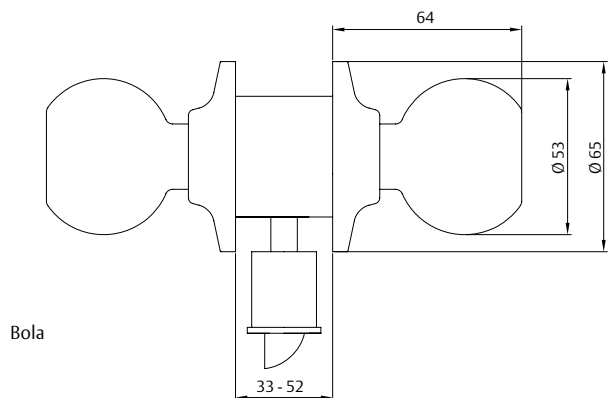

Entrada	Modelo	Entrada	Acabado	Embalaje
	3900	U0 UV	CM - CR - LM - LP - NS LA - BL - NE - AE	20
Puertas a condonar	Modelo	Entrada	Acabado	Embalaje
	3901	U0	CM - CR - LM - LP - NS LA - BL - NE - AE	20
Aula	Modelo	Entrada	Acabado	Embalaje
	3901AP	U0	CCM - CR - LM - LP - NS LA - BL - NE - AE	20
Aula	Modelo	Entrada	Acabado	Embalaje
	3902	U0	CM - CR - LM - LP - NS LA - BL - NE - AE	20
Baño	Modelo	Entrada	Acabado	Embalaje
	3903	U0 UV	CM - CR - LM - LP - NS LA - BL - NE - AE	20
Paso	Modelo	Entrada	Acabado	Embalaje
	3905	U0 UV	CM - CR - LM - LP - NS LA - BL - NE - AE	20



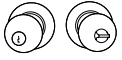
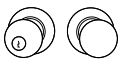

Oficina	Modelo	Entrada	Acabado	Embalaje
	3907	U0	CM - CR - LM - LP - NS LA - BL - NE - AE	20
Entrada	Modelo	Entrada	Acabado	Embalaje
	3920	50	CM - CR - LM - LP - NS LA - BL - NE - AE	20
Pomo tirador	Modelo	Entrada	Acabado	Embalaje
	3931	00	CM - CR - LM - LP - NS LA - BL - NE - AE	20
Doble tirador	Modelo	Entrada	Acabado	Embalaje
	3932	00	CM - CR - LM - LP - NS LA - BL - NE - AE	20
Doble cuadradillo	Modelo	Entrada	Acabado	Embalaje
	3933	00	CM - CR - LM - LP - NS LA - BL - NE - AE	20
Pomo - cuadradillo	Modelo	Entrada	Acabado	Embalaje
	3934	00	CM - CR - LM - LP - NS LA - BL - NE - AE	20

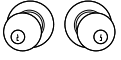

Sistema cuadradillo

Serie Tulipa 3500

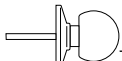

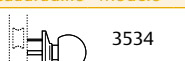
Entrada	Modelo	Entrada	Acabado	Embalaje
	3500	U0 UV	CM - CR - LM - LP - NS LA - BL - NE - AE	20
Puertas a condonar	Modelo	Entrada	Acabado	Embalaje
	3501	U0	CM - CR - LM - LP - NS LA - BL - NE - AE	20
Aula	Modelo	Entrada	Acabado	Embalaje
	3501AP	U0	CM - CR - LM - LP - NS LA - BL - NE - AE	20
Aula	Modelo	Entrada	Acabado	Embalaje
	3502	U0	CM - CR - LM - LP - NS LA - BL - NE - AE	20
Baño	Modelo	Entrada	Acabado	Embalaje
	3503	U0 UV	CM - CR - LM - LP - NS LA - BL - NE - AE	20
Paso	Modelo	Entrada	Acabado	Embalaje
	3505	U0 UV	CM - CR - LM - LP - NS LA - BL - NE - AE	20

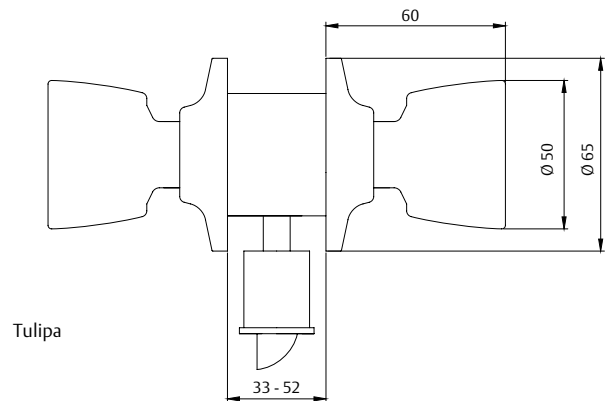
Oficina	Modelo	Entrada	Acabado	Embalaje
	3507	U0	CM - CR - LM - LP - NS LA - BL - NE - AE	20
Entrada	Modelo	Entrada	Acabado	Embalaje
	3520	U0	CM - CR - LM - LP - NS LA - BL - NE - AE	20
Pomo tirador	Modelo	Entrada	Acabado	Embalaje
	3531	U0	CM - CR - LM - LP - NS LA - BL - NE - AE	20
Doble tirador	Modelo	Entrada	Acabado	Embalaje
	3532	U0	CM - CR - LM - LP - NS LA - BL - NE - AE	20
Doble cuadradillo	Modelo	Entrada	Acabado	Embalaje
	3533	U0	CM - CR - LM - LP - NS LA - BL - NE - AE	20
Pomo - cuadradillo	Modelo	Entrada	Acabado	Embalaje
	3534	U0	CM - CR - LM - LP - NS LA - BL - NE - AE	20



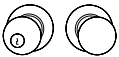
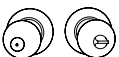

Sistema cuadradillo

Serie Nobel 3800

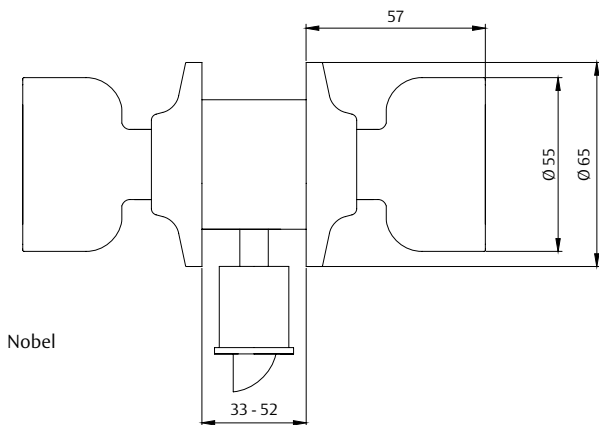
Entrada	Modelo	Entrada	Acabado	Embalaje
	3800	U0	CM - CR - LM - LP - NS LA	20
Aula	Modelo	Entrada	Acabado	Embalaje
	3802	U0	CM - CR - LM - LP - NS LA	20
Baños	Modelo	Entrada	Acabado	Embalaje
	3803	U0	CM - CR - LM - LP - NS LA	20
Paso	Modelo	Entrada	Acabado	Embalaje
	3805	U0	CM - CR - LM - LP - NS LA	20



Serie California 3550

Entrada	Modelo	Entrada	Acabado	Embalaje
	3550	U0	CM - CR - LM - LP - NS LA	20
Aula	Modelo	Entrada	Acabado	Embalaje
	3552	U0	CM - CR - LM - LP - NS LA	20
Baños	Modelo	Entrada	Acabado	Embalaje
	3553	U0	CM - CR - LM - LP - NS LA	20
Paso	Modelo	Entrada	Acabado	Embalaje
	3555	U0	CM - CR - LM - LP - NS LA	20

